

PIN HEADERS

SINGLE ROW STRAIGHT

- Industry compatible
- Competitively priced
- Various plated contacts available
- 2.54mm pitch

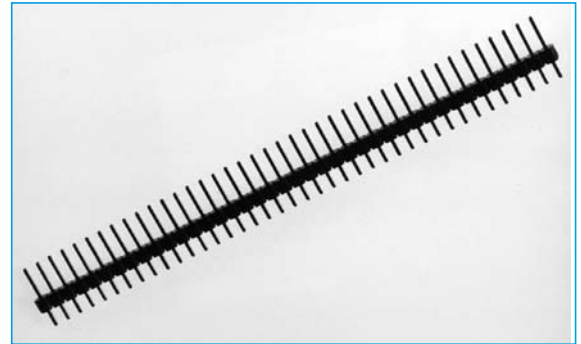

SECTION 8

SPECIFICATION

Material & Finish

Contact Material:	Brass
Insulator Material:	PBT & Glass-Fibre Reinforced UL94V-0
Current Rating:	1 A DC
Contact Resistance:	30M Ω Max at 6V DC 0.3A
Insulator Resistance:	1000M Ω Min at 500V DC
Dielectric Withstanding	
Voltage:	500V AC for One Minute
Operating Temperature:	-40°C to + 105°C

OUTLINE DRAWING

A = 2.54 x N° of Positions
 B = (2.54 x N° of Positions)-1

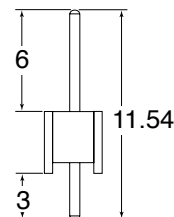
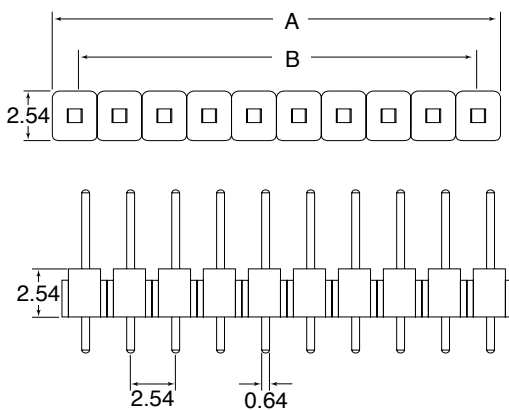

For other dimension variations please consult office

ORDERING INFORMATION

DBC	PH	C15	04	A	G	1	-XXX
Dubilier Connectors	Pin Header Connector	Series	N° of Ways 02=02way Thro to 40=40way	Contact Material A=Brass	Contact Plating G= Gold Flash S=Selective T=Tin Plated other plating Available	Colour 1=Black	Unique Special Code *See Below

*Dubilier will allocate a special code to distinguish pin lengths if required

PIN HEADERS

- Industry compatible
- Competitively priced
- Various plated contacts available
- 2.54mm pitch

SINGLE ROW RIGHT ANGLE



SECTION 8

SPECIFICATION

Material & Finish

Contact Material:	Brass
Insulator Material:	PBT & Glass-Fibre Reinforced UL94V-0
Current Rating:	2 Amp
Contact Resistance:	30M Ω Max
Insulator Resistance:	3000M Ω Min
Dielectric Withstanding Voltage:	500V AC for One Minute
Operating Temperature:	-40°C to + 105°C

OUTLINE DRAWING

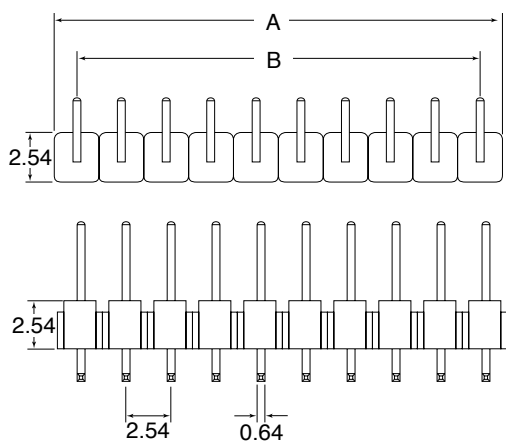

A = 2.54 x N° of Positions
 B = (2.54 x N° of Positions)-1

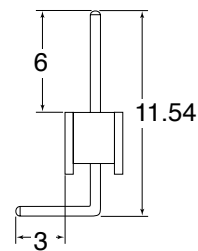

For other dimension variations please consult office

ORDERING INFORMATION

DBC	PH	C16	04	A	G	1	-XXX
Dubilier Connectors	Pin Header Connector	Series	N° of Ways 02=02way Thro to 40=40way	Contact Material A=Brass	Contact Plating G= Gold Flash S=Selective T=Tin Plated other plating Available	Colour 1=Black	Unique Special Code *See Below

*Dubilier will allocate a special code to distinguish pin lengths if required

PIN HEADERS

DUAL ROW STRAIGHT

- Industry compatible
- Competitively priced
- Various plated contacts available
- 2.54mm pitch

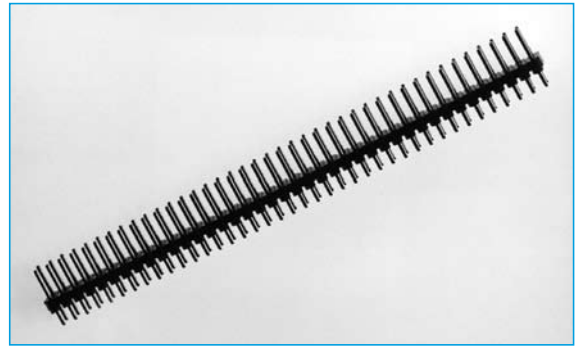

SECTION 8

SPECIFICATION

Material & Finish

Contact Material:	Brass
Insulator Material:	PBT & Glass-Fibre Reinforced UL94V-0
Current Rating:	1 A DC
Contact Resistance:	30M Ω Max at 6V DC 0.3A
Insulator Resistance:	1000M Ω Min at 500V DC
Dielectric Withstanding	
Voltage:	500V AC for One Minute
Operating Temperature:	-40°C to + 105°C

OUTLINE DRAWING

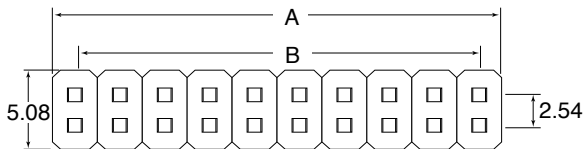

$A = 2.54 \times N^{\circ}$ of Positions
 $B = (2.54 \times N^{\circ}$ of Positions)-1

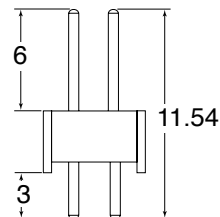
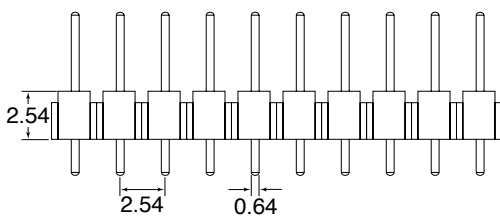

For other dimension variations please consult office

ORDERING INFORMATION

DBC	PH	C17	04	A	G	1	-XXX
Dubilier Connectors	Pin Header Connector	Series	N° of Ways 02=2x2way Thro to 40=40x2way	Contact Material A=Brass	Contact Plating G= Gold Flash S=Selective T=Tin Plated other plating Available	Colour 1=Black	Unique Special Code *See Below

*Dubilier will allocate a special code to distinguish pin lengths if required

PIN HEADERS

- Industry compatible
- Competitively priced
- Various plated contacts available
- 2.54mm pitch

DUAL ROW RIGHT ANGLE

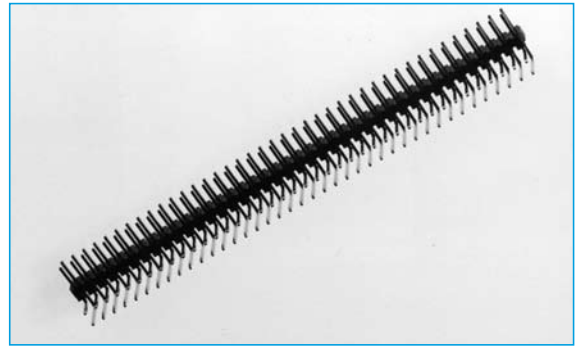

SECTION 8

SPECIFICATION

Material & Finish

Contact Material:	Brass
Insulator Material:	PBT & Glass-Fibre Reinforced UL94V-0
Current Rating:	1 A DC
Contact Resistance:	30M Ω Max at 6V DC 0.3A
Insulator Resistance:	1000M Ω Min at 500V DC
Dielectric Withstanding	
Voltage:	500V AC for One Minute
Operating Temperature:	-40°C to + 105°C

OUTLINE DRAWING

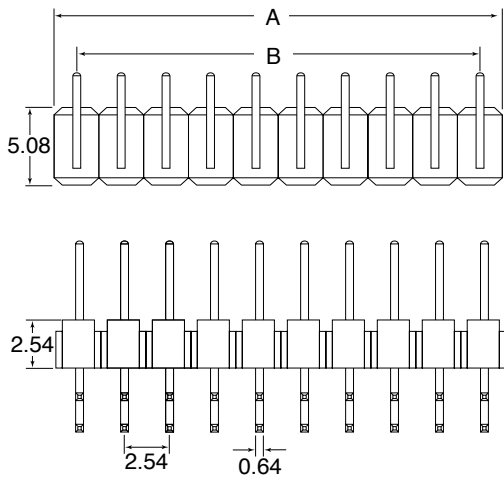

A = 2.54 x N° of Positions
 B = (2.54 x N° of Positions)-1

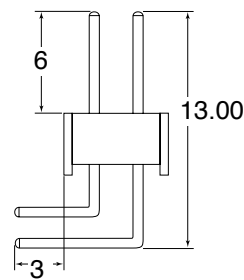

For other dimension variations please consult office

ORDERING INFORMATION

DBC	PH	C18	04	A	G	1	-XXX
Dubilier Connectors	Pin Header Connector	Series	N° of Ways 02=2x2way Thro to 40=40x2way	Contact Material A=Brass	Contact Plating G= Gold Flash S=Selective T=Tin Plating other plating Available	Colour 1=Black	Unique Special Code *See Below

*Dubilier will allocate a special code to distinguish pin lengths if required

PIN HEADERS

TRIPLE ROW STRAIGHT

- Industry compatible
- Competitively priced
- Various plated contacts available
- 2.54mm pitch

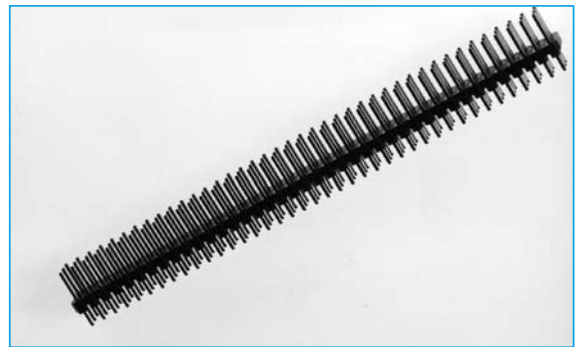

SECTION 8

SPECIFICATION

Material & Finish

Contact Material:	Brass
Insulator Material:	PBT & Glass-Fibre Reinforced UL94V-0
Current Rating:	1 A DC
Contact Resistance:	30M Ω Max at 6V DC 0.3A
Insulator Resistance:	1000M Ω Min at 500V DC
Dielectric Withstanding	
Voltage:	500V AC for One Minute
Operating Temperature:	-40°C to + 105°C

OUTLINE DRAWING

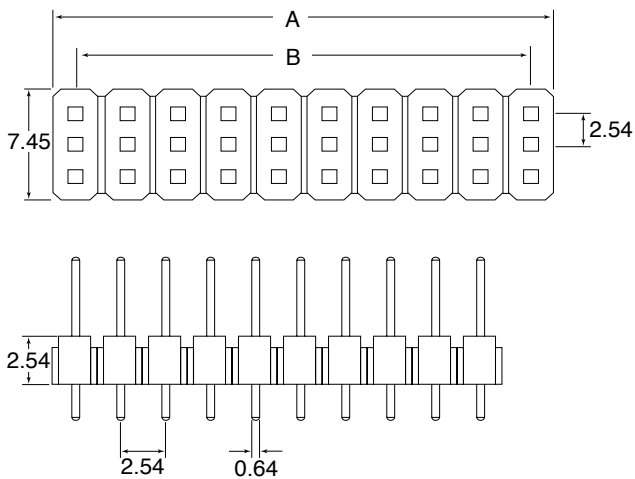

$A = 2.54 \times N^{\circ}$ of Positions
 $B = (2.54 \times N^{\circ}$ of Positions)-1

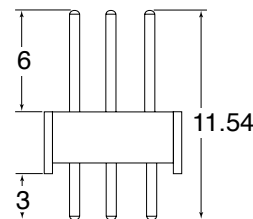

For other dimension variations please consult office

ORDERING INFORMATION

DBC	PH	C21	09	A	G	1	-XXX
Dubilier Connectors	Pin Header Connector	Series	N° of Ways 02=2x3way Thro to 40=40x3way	Contact Material A=Brass	Contact Plating G= Gold Flash S=Selective T=Tin Plated other plating Available	Colour 1=Black	Unique Special Code *See Below

*Dubilier will allocate a special code to distinguish pin lengths if required

PIN HEADERS

- Industry compatible
- Competitively priced
- Various plated contacts available
- 2.54mm pitch

TRIPLE ROW RIGHT ANGLE

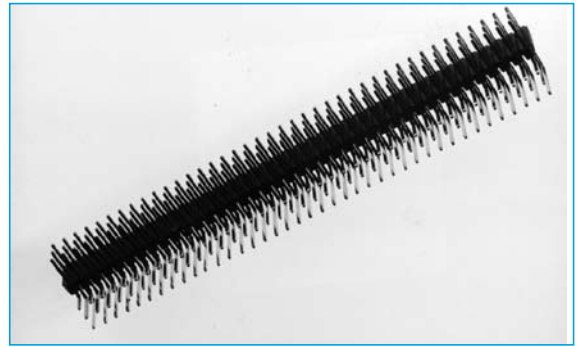

SPECIFICATION

Material & Finish

Contact Material:	Brass
Insulator Material:	PBT & Glass-Fibre Reinforced UL94V-0
Current Rating:	1 A DC
Contact Resistance:	30M Ω Max at 6V DC 0.3A
Insulator Resistance:	1000M Ω Min at 500V DC
Dielectric Withstanding	
Voltage:	500V AC for One Minute
Operating Temperature:	-40°C to + 105°C

OUTLINE DRAWING

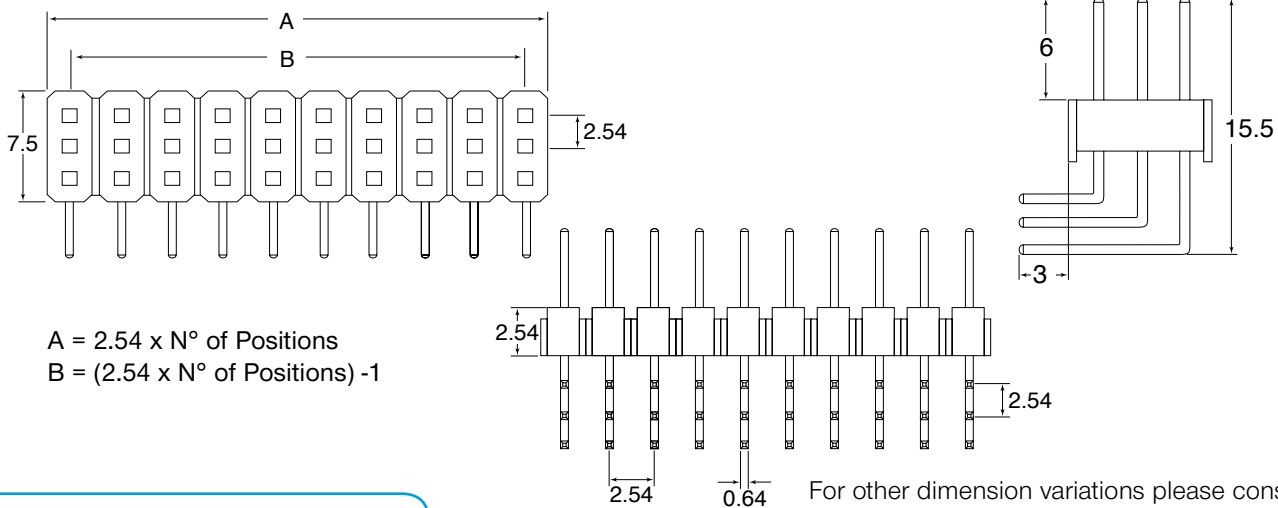

ORDERING INFORMATION

DBC	PH	C22	06	A	G	1	-XXX
Dubilier Connectors	Pin Header Connector	Series	N° of Ways 02=2x3way Thro to 40=40x3way	Contact Material A=Brass	Contact Plating G= Gold Flash S=Selective T=Tin Plated other plating Available	Colour 1=Black	Unique Special Code *See Below

*Dubilier will allocate a special code to distinguish pin lengths if required

PIN HEADERS

SINGLE ROW SMT STRAIGHT

- Industry Compatible
- Competitively priced
- Various plated contacts available
- 2.54mm pitch
- Surface mount mounting

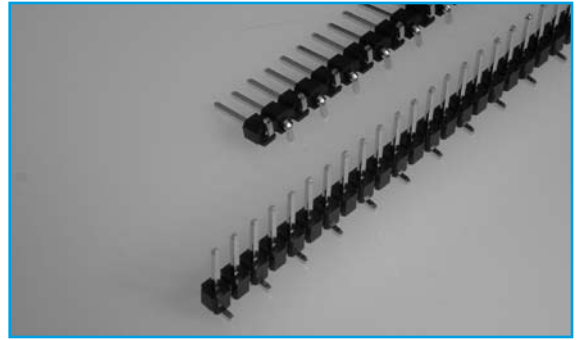

SECTION 8

SPECIFICATION

Material & Finish

Contact Material:	Brass
Insulator Material:	PBT & Glass-Fibre Reinforced UL94V-0
Current Rating:	1 A DC
Contact Resistance:	30M Ω Max at 6V DC 0.3A
Insulator Resistance:	1000M Ω Min at 500V DC
Dielectric Withstanding	
Voltage:	500V AC for One Minute
Operating Temperature:	-40°C to + 105°C

OUTLINE DRAWING

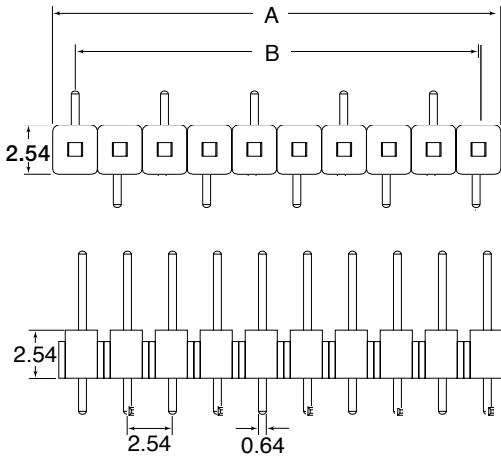

A = 2.54 * Position No
 B = 2.54 * (Position No-1)

Standard part have dimensions E=6mm, F=1.3, G=9.18
 Other pin lengths available upon request

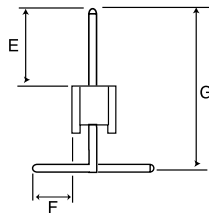

ORDERING INFORMATION

DBC	PH	C23	32	A	G	1	-XXX
Dubilier Connectors	Pin Header Connector	Series	No. of Ways 02= 2 Ways Thru to 40= 40 Ways	Contact Material A= Brass	Contact Plating G= Gold Flash T= Tin Plated S= Selective	Colour 1= Black	Options Unique Special Code *See below

*Dubilier will allocate a special code to distinguish the pins lengths E, F and G if required

PIN HEADERS

- Industry Compatible
- Competitively priced
- Various plated contacts available
- 2.54mm pitch
- Various pin lengths available

DUAL BODY SINGLE ROW

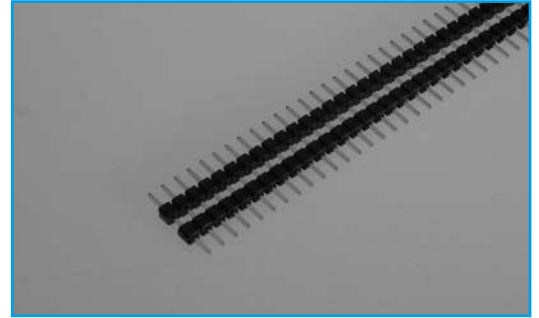

SECTION 8

SPECIFICATION

Material & Finish

Contact Material:	Brass
Insulator Material:	PBT & Glass-Fibre Reinforced UL94V-0
Current Rating:	1 A DC
Contact Resistance:	30M Ω Max at 6V DC 0.3A
Insulator Resistance:	1000M Ω Min at 500V DC
Dielectric Withstanding	
Voltage:	500V AC for One Minute

Operating Temperature: -40°C to + 105°C

OUTLINE DRAWING

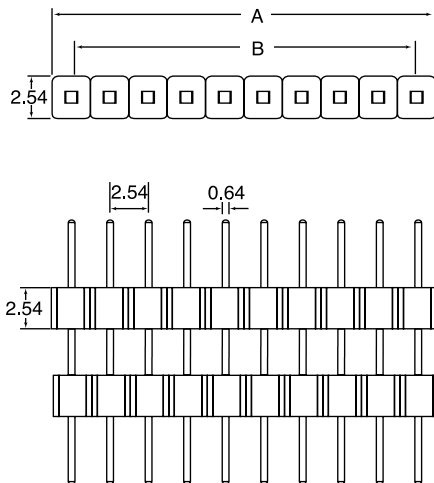

A	2.54 * Position No.
B	2.54 * (Position No.-1)

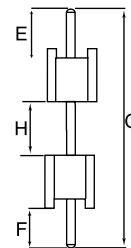

ORDERING INFORMATION

DBC	PH	C19	32	A	G	1	-XXX
Dubilier Connectors	Pin Header Connector	Series	No. of Ways 02= 2ways Thru to 40 = 40ways	Contact Material A= Brass	Contact Plating G= Gold Flash T= Tin Plated S= Selective	Colour 1= Black	Unique Special Code *See below

*Dubilier will allocate a special code to distinguish the pins lengths E, F, H and G

PIN HEADERS

- Industry Compatible
- Competitively priced
- Various plated contacts available
- Various pin lengths available
- 2.54mm pitch

DUAL BODY DOUBLE ROW

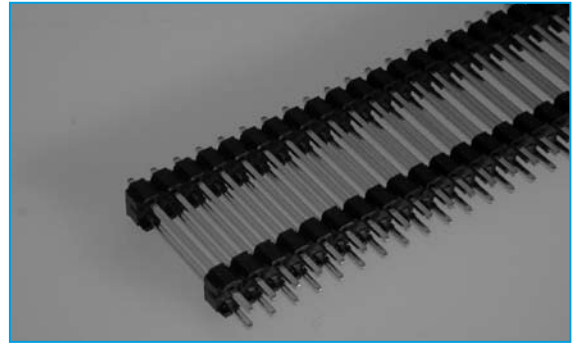

SECTION 8

SPECIFICATION

Material & Finish

Contact Material:	Brass
Insulator Material:	PBT & Glass-Fibre Reinforced UL94V-0
Current Rating:	1 A DC
Contact Resistance:	30M Ω Max at 6V DC 0.3A
Insulator Resistance:	1000M Ω Min at 500V DC
Dielectric Withstanding	
Voltage:	500V AC for One Minute
Operating Temperature:	-40°C to + 105°C

OUTLINE DRAWING

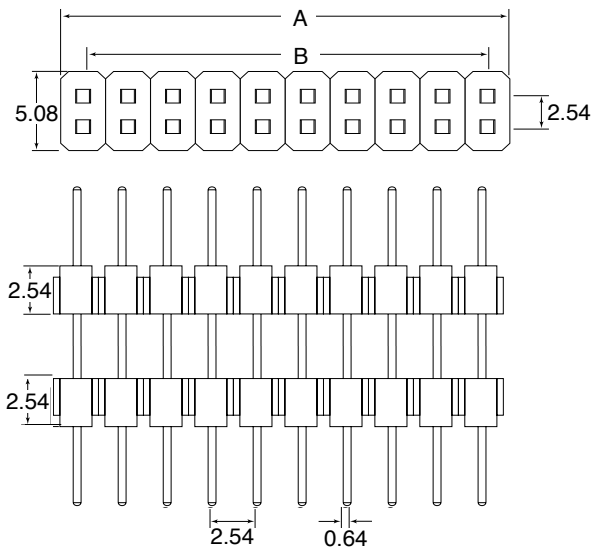

A = 2.54 x Position No
 B = 2.54 x (Position N^o -1)

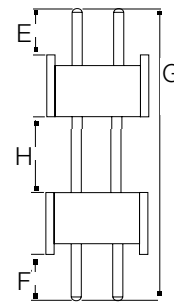

ORDERING INFORMATION

DBC	PH	C20	32	A	G	1	-XXX
Dubilier Connectors	Pin Header Connector	Series	No. of Ways 02= 2x2 Ways Thro to 40= 40x2 Ways	Contact Material A= Brass	Contact Plating G= Gold Flash T= Tin Plated S= Selective	Colour 1= Black	Unique Special Code *See below

*Dubilier will allocate a special code to distinguish the pins lengths E,H,F and G